

# INSTALLATION PLAN

FRONT

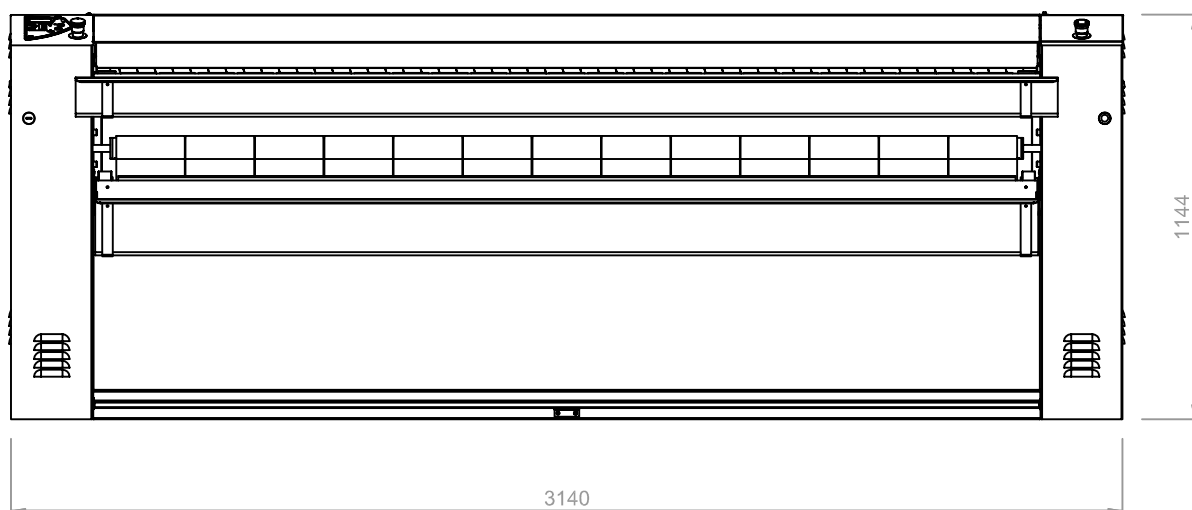

TOP

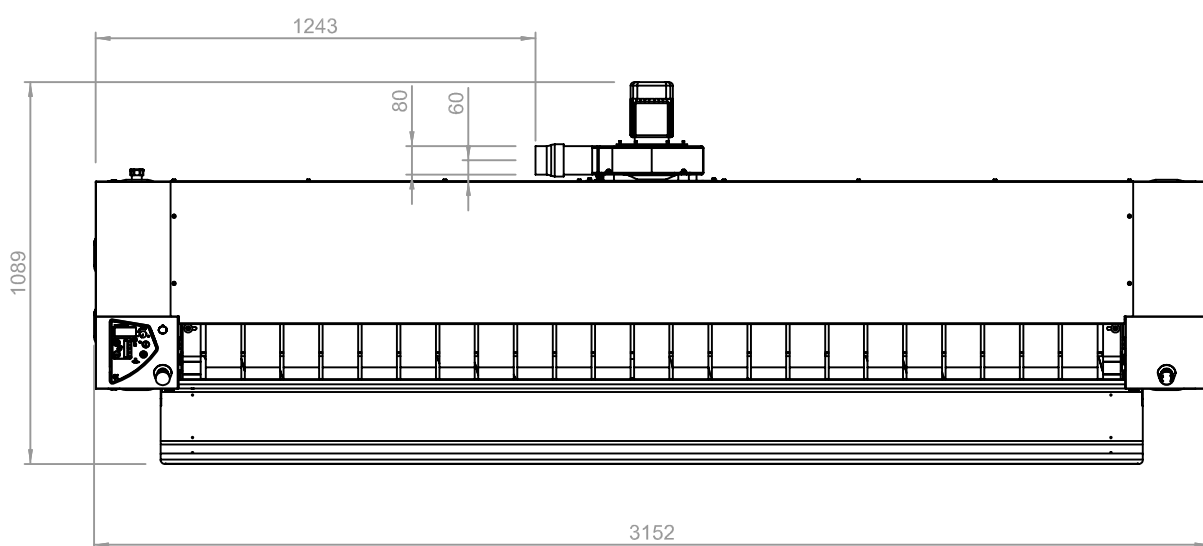

## INSTALLATION PLAN

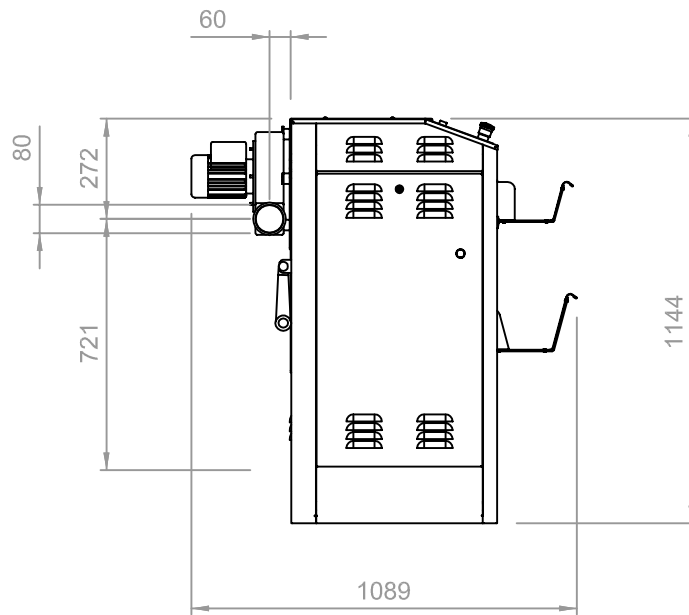

### SIDE

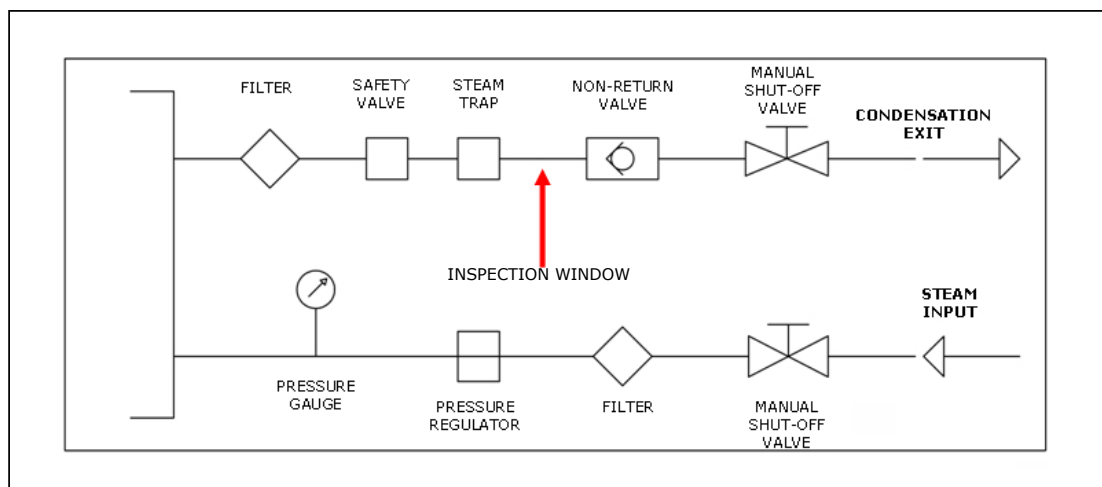

### STEAM CONNECTION



## WHAT YOU NEED

Electrical cable + industrial plug			
	V.230/1/50Hz	V.230/3/50Hz	V.400/3N/50Hz
	5 Amps	not available	not available
Motor power	1 kW	-	-
Differential magnetothermal switch	$I_{dn} = 0.03 \text{ A}$	-	-
Steam connection	G 3/4" M	-	-
Average steam consumption	32 kg/h	-	-
Minimum steam pressure required	4 bar	-	-
Ducting	$\varnothing 80 \text{ mm}$ , 280 m <sup>3</sup> /h	-	-
Condensate exit	G 3/8" M	-	-
Clearance around the ironer	back: 500 mm - right: 500 mm - left: 500 mm		