

INFORMATIONEN ZUR INBETRIEBNAHME

VORDERANSICHT

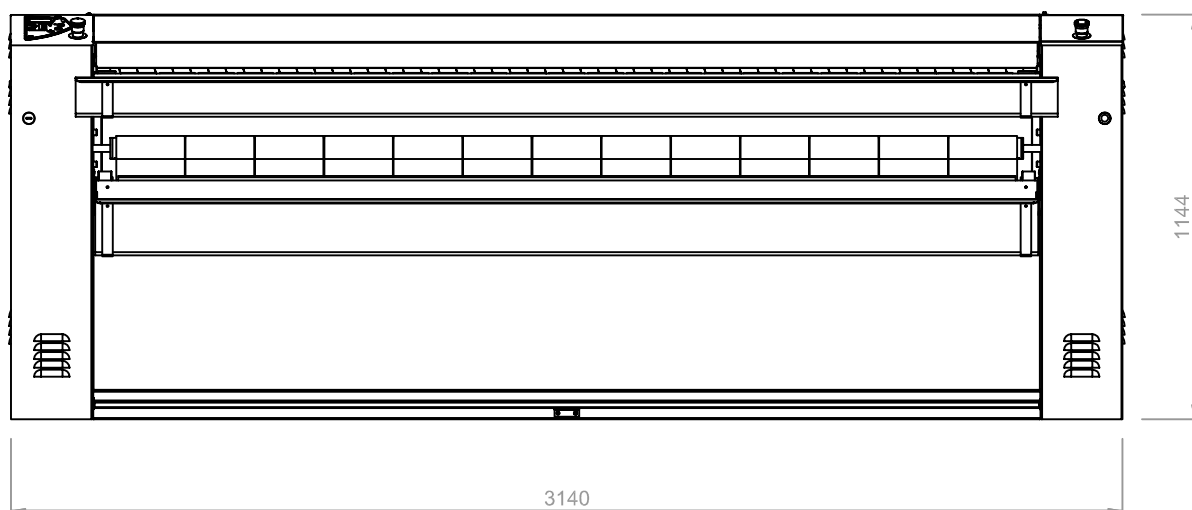

DRAUFSICHT

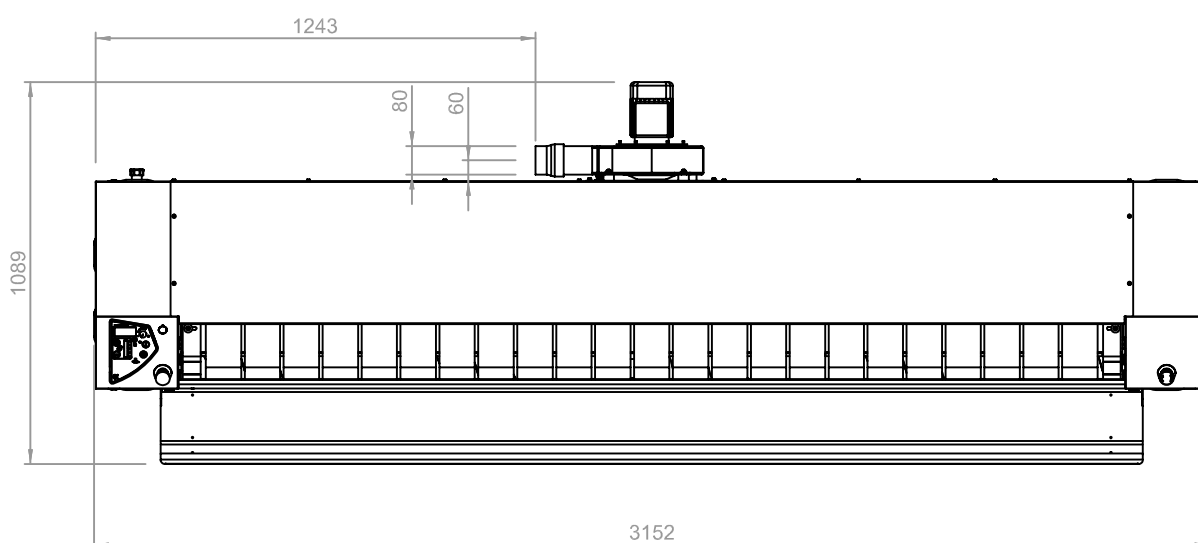

INFORMATIONEN ZUR INBETRIEBNAHME

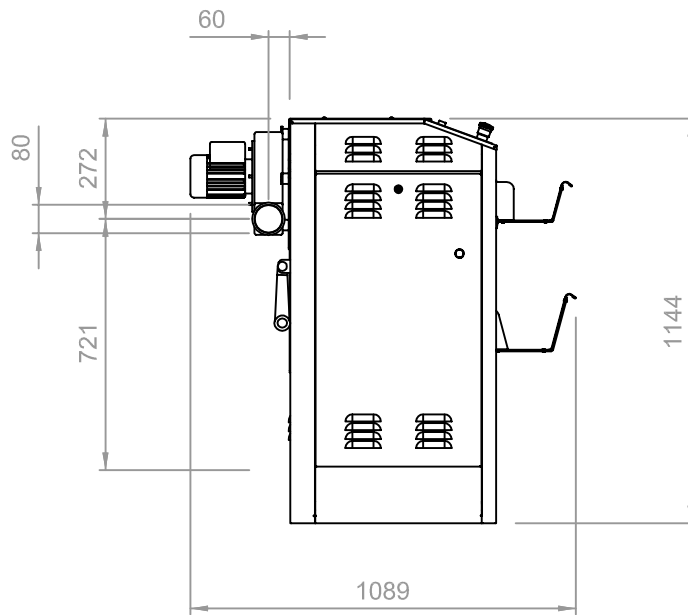

SEITENANSICHT

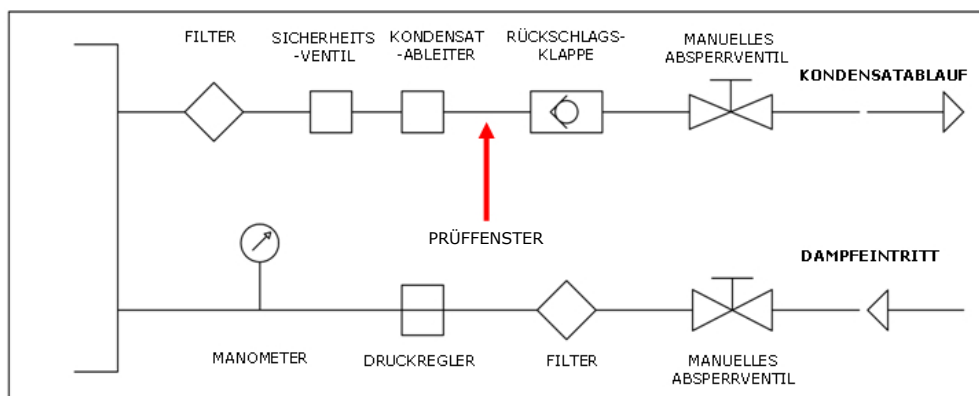

DAMPFANSCHLUSS



TECHNISCHE ANFORDERUNGEN

Elektrokabel + Stecker			
	V.230/1/50Hz	V.230/3/50Hz	V.400/3N/50Hz
	5 A	n.v.	n.v.
Motorleistung	1 kW	-	-
Magnetothermischer Differentialschalter	$I_{dn} = 0.03 \text{ A}$	-	-
Dampfanschluss	G 3/4" M	-	-
Durchschnitts-Dampfverbrauch	32 kg/h	-	-
Erforderlicher Dampf-Mindestdruck	4 bar	-	-
Dampfabzug	Ø80 mm, 280 m ³ /h	-	-
Kondensatableitung	G 3/8" M	-	-
Platz um die Maschine	hinten: 500 mm - rechts: 500 mm - links: 500 mm		